

Euro hinge attachment and adjustment

Door installation

To install, place the hinge on the mounting plate and push the back of the hinge arm down with finger pressure. The "click" sound confirms a secure attachment.

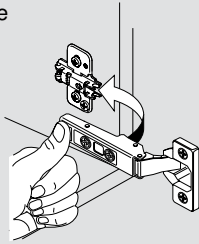

Door removal

Release the lever under the hinge arm to remove.

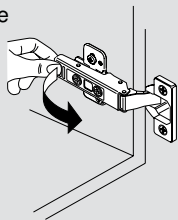

CLIP top BLUMOTION deactivation

For small or light doors, the BLUMOTION can be deactivated on one of the hinges. Door must be closed once for the deactivation to be complete. To reactivate, move switch back to the original position.

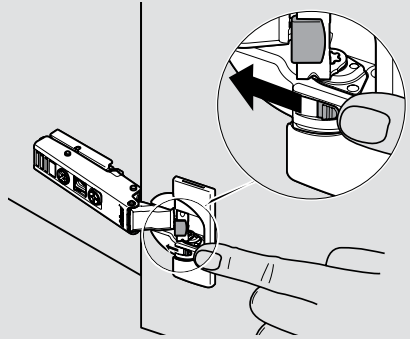

Side adjustment

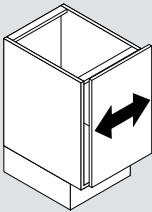

Rotate the front screw to increase or decrease the door overlay (+/- 2 mm).

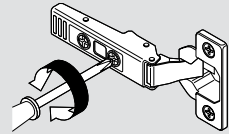

Depth adjustment

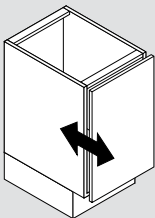

Rotate the rear spiral tech cam screw to adjust the door position (+ 3/- 2 mm).

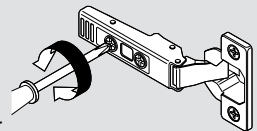

For CLIP hinges, loosen the rear screws on all hinges, adjust and retighten.

800-438-6788
www.blum.com

CLIP mounting plate adjustments

Height adjustment

Cam wing mounting plate

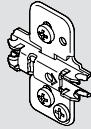
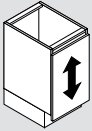

Rotate cam screw on the mounting plate to adjust door position (+/- 2 mm).

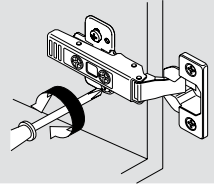

One-piece wing plate

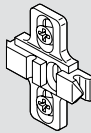
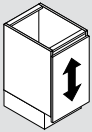

Loosen screws on the mounting plate. Adjust door to position and tighten screws (+/- 3 mm).

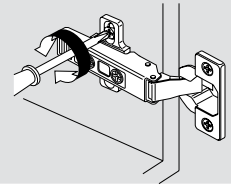

Cam in-line mounting plate

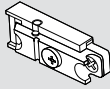
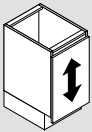

Rotate cam screw on the mounting plate to adjust door position (+/- 2 mm).

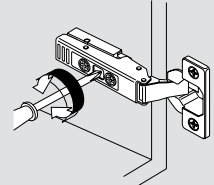

Face frame cam adapter plate

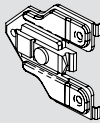
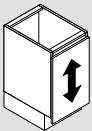

Rotate cam screw on the mounting plate to adjust door position (+/- 2 mm).

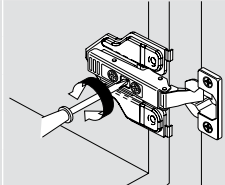

Face frame adapter plate

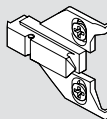
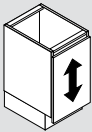

Loosen screws on the mounting plate. Adjust door to position and tighten screws (+/- 2 mm).

