

# CG-20 Corner Guard

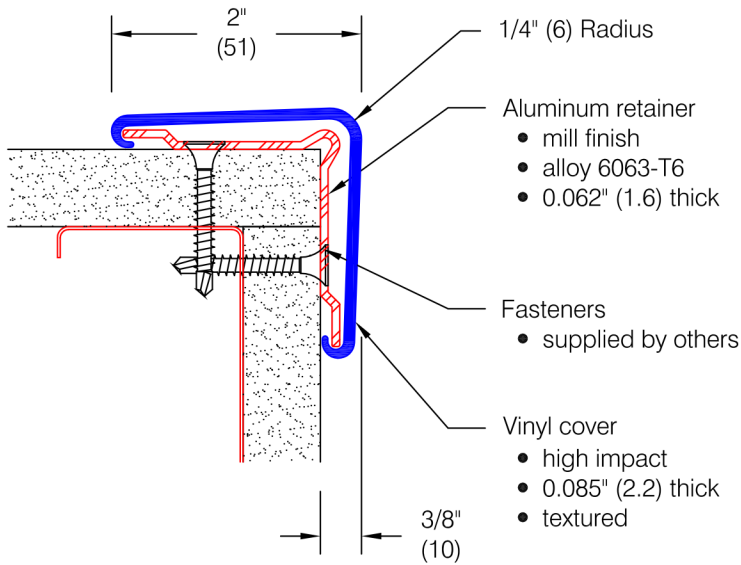

## Features:

- Class A fire rating
- "Surface Mount" installation follows completion of drywall mounting
- Stock lengths: 4'-0" (1219), 8'-0" (2438), 9'-0" (2743), 10'-0" (3048), and 12'-0" (3658)
- Custom cut lengths available
- Standard with textured top and bottom closure caps

## Finishes:

- Vinyl cover (textured)
- Manufacturer's standard colors
  - Custom colors available
- Aluminum retainer
- Mill finish #405

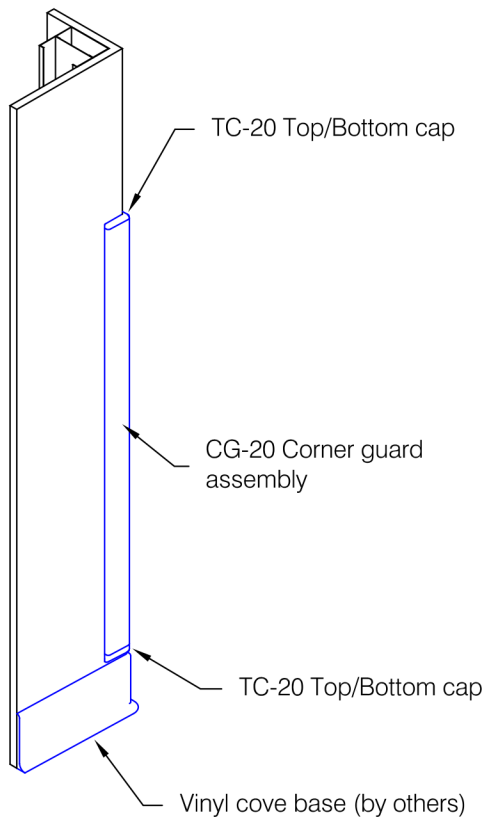

## Application Diagram

\* **Partial height installation with top and bottom caps shown. Full height installations may not require top or bottom cap.**

